

Information Theory and Networks

Lecture 27: A Brief History of Networks

Matthew Roughan

`<matthew.roughan@adelaide.edu.au>`

`http://www.maths.adelaide.edu.au/matthew.roughan/
Lecture_notes/InformationTheory/`

School of Mathematical Sciences,
University of Adelaide

September 20, 2013

Processing delay

Section 1

Computer Networks

Computer pre-history

- The original “computers” were people
 - ▶ numerical algorithms performed with pencil and paper
 - ▶ later with mechanical adding machines
- Algorithms were often parallelized
 - ▶ multiple computers worked on same problem to speed up or check calculations
 - ▶ a “computer network” was result of passing bits of paper

20th century

Computer networks:

- First generation of electrical digital computers 1940s
- Second generation – late 1950s and early 1960s
 - ▶ transistor invented in 1947 (at AT&T)
 - ▶ direct networks: peripherals such as printers directly attached to computers
- Third generation, post-1964
 - ▶ integrated circuits
 - ▶ real computer networks start
- 1965, Moore's law discovered
 - ▶ computers get better and better ...

Moore's Law

Moore's law: the speed of digital hardware increases by a factor of two every 18 months, or the number of transistors on a chip doubles, or the cost halves [Moo65].

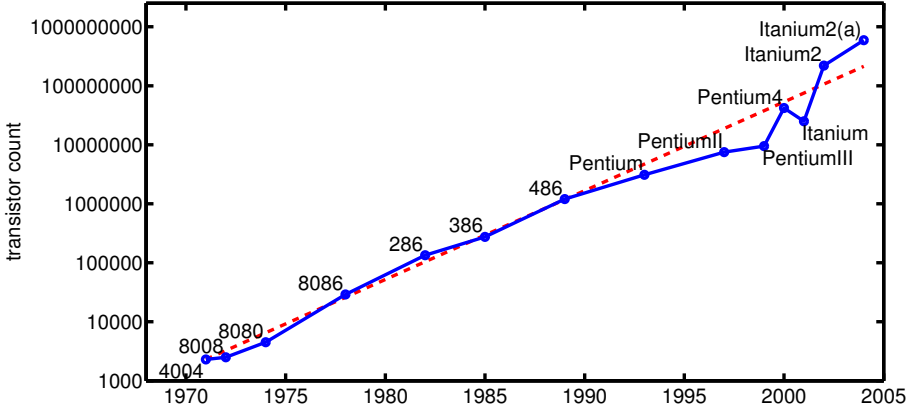

Actually looks more like a factor of 2 every 2 years.

Gilder's Law

Gilder's law: theoretical transmission capacity of a link increases by a factor of two every 12 months.

- <http://www.seas.upenn.edu/~gaj1/promise.html>
- <http://www.dtc.umn.edu/~odlyzko/doc/tv.internet.txt>
- <http://telecomvisions.com/articles/beyondip/>
- transmission capacity is still behind storage
 - ▶ 2000, backbones in US carried 144 PB/year, total disk capacity 3000 PB
 - ★ it would take 20 years to carry all the data
 - ▶ 2005, 100 GB disk is common, 1.5 Mbps
 - ★ it would take 6 days to carry all the data
 - ▶ network is catching up?

Networking drivers

- Moore's law drives PC business
- Gilder's law drives networks
 - ▶ something suss here – lets discuss later
- Metcalfe's law also drives the Internet
 - ▶ The value of a network is proportional to the square of the number of users.
 - ▶ hence the failure of many “video-phone” trials
 - ★ but success of most recent “camera phones”

The Internet

- Leonard Kleinrock at MIT published the first paper on **packet switching** theory in, July 1961 [L.K61].
- J.C.R. Licklider of MIT wrote memos “Galactic Network”, and later convinced DARPA to fund, 1962.
- Baran defence proposal for robust network was a packet switched network, 1962 [Bar64].
- Thomas Merrill, Larry Roberts, first network 1965
- Roberts’s plan for the “ARPANET”, published 1967
- IMP’s (built by BBN) connected 1968-69
- 1972: First public demo, e-mail invented
- Vinton Cerf and Robert Kahn, TCP/IP, 1973

<http://www.isoc.org/internet/history/brief.shtml>

The Early Internet

Paul Baran, 1960s, envisioned a comm.s network that would survive a major enemy attack. The sketch shows three network topologies described in [Bar64].

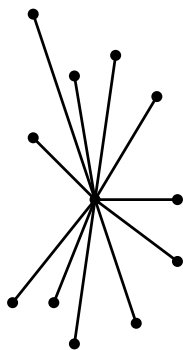

centralized

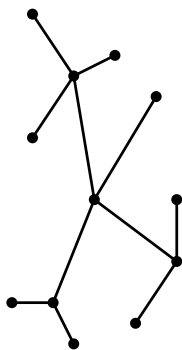

decentralized

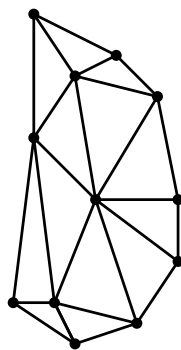

distributed

Original available at
<http://www.cybergeography.org/atlas/historical.html>

The Early Internet

A rough sketch map of the possible topology of ARPANET by Larry Roberts. Drawn in the late 1960s as part of the planning for the network [HL96, p.50].

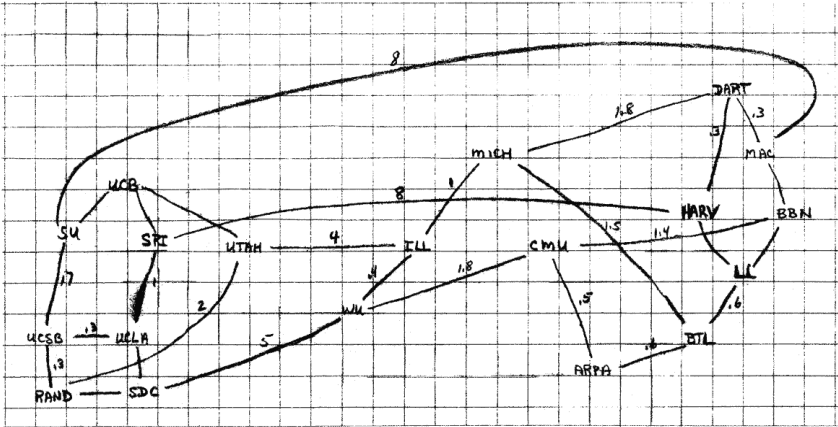

<http://www.cybergeography.org/atlas/historical.html>

The Early Internet

The first node on ARPANET at University California Los Angeles (UCLA) on the 2nd of September 1969 [CK90].

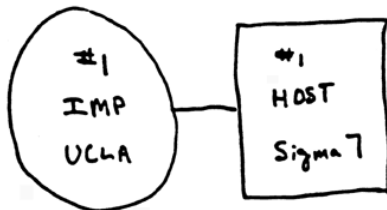

IMP = Interface Message Processor
what we would call a router

TIP = Terminal IMP

IMP to which terminals can directly connect

Host = computer (which provides services)

Available at

<http://www.cybergeography.org/atlas/historical.html>

The Early Internet

Dec 1969 "ARPA NETWORK". 4 nodes: Uni. of California Los Angeles (UCLA), Uni. of California Santa Barbara (UCSB), Uni. of Utah and the Stanford Research Institute (SRI) [CK90].

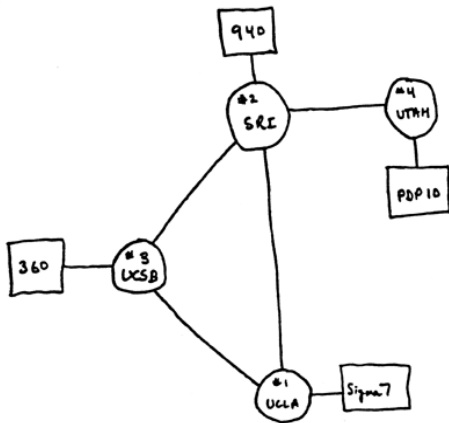

Available at

<http://www.cybergeography.org/atlas/historical.html>

The Internet: the 80's

- new developments
 - ▶ Personal Computers (PCs)
 - ⇒ lots more computers to network
 - ▶ Ethernet (1973, Robert Metcalfe) creates LANs
- the Internet
 - ▶ TCP/IP provides a way to hook up the LANs and PC over wide areas (standard in 1980)
 - ▶ scale gets bigger
 - ★ numbers increase
 - ★ becomes international
 - ▶ partitioning
 - ★ ARPANET splits into MILNET and ARPANET in early 80's, followed by further additions

The Internet: the 80's

ARPANET/MILNET [CK90].

ARPANET/MILNET GEOGRAPHIC MAP, APRIL 1984

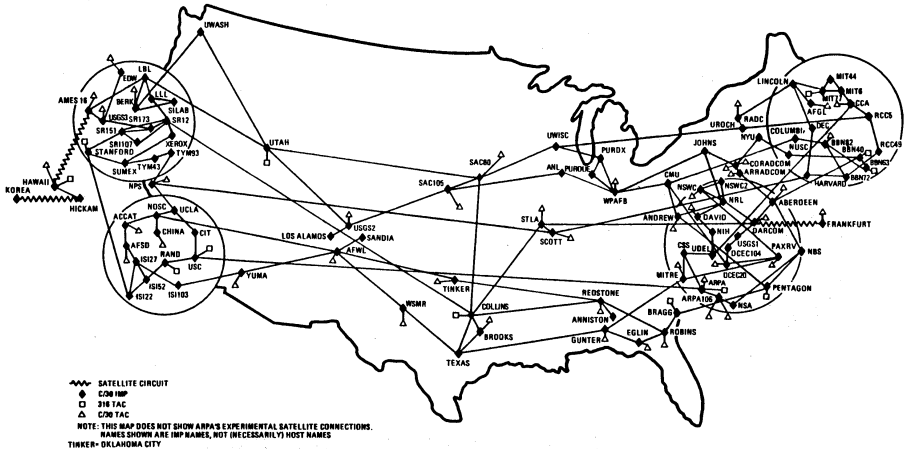

The Internet: the 90's

- ARPANET decommissioned 1990
 - ▶ NSF Backbone connects many other networks
 - ★ Australia connected in 1990 [Abb99]

It was the first, and being first, was best,
but now we lay it down to rest.
Now pause with me a moment, shed some tears.
For auld langae syne, for love, for years and years
of faithful service, duty done, I weep.
Lay down thy packet, now, O friend, and sleep.

Vinton Cerf, 1989

- commercial Internet services evolve
 - ▶ 1995 NSFNET terminated (replaced by vBNS)
 - ▶ effectively fully privatised Internet
 - ▶ links through exchange points

The Internet: the 90's

Australia's network 1991

Australian Academic and Research Network

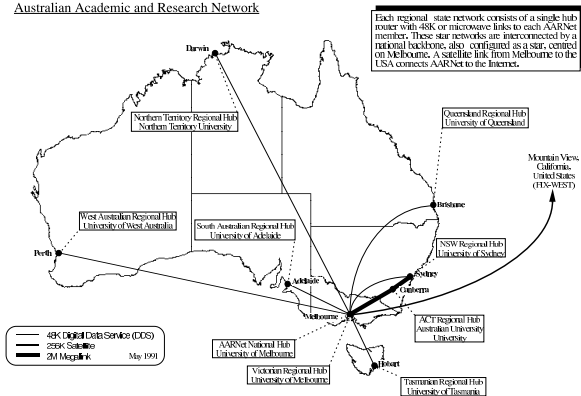

<http://www.ucs.ed.ac.uk/fmd/unix/edftp/pub/maps/>

New network

<http://www.aarnet.edu.au/engineering/aarnet3/>

The Internet: the 90's

<http://www.w3.org/History.html>

- 1990: World Wide Web
Tim Berners-Lee created HyperText Markup Language, or HTML. Along with URL (Uniform Resource Locators), and HTTP (HyperText Transfer Protocol), created the web. Based on earlier work at CERN (1980).
- 1993: Mosaic (Marc Andreessen, NCSA)
Mosaic became the first popular web browser. It was not only easy to use to access the World Wide Web, but it was also extremely easy to download and install!
- Killer app = the Internet takes off in a big way

Early Internet Bandwidth Growth

All the time **backbone** link speeds have been growing

- 1969: 50kbps
- 1988: NSFNET backbone upgraded to T1 (1.544Mbps)
- 1991: NSFNET backbone upgraded to T3 (44.736Mbps)
- 1996: MCI upgrades Internet backbone 622Mbps
- 1999: MCI/Worldcom begins upgrading the US backbone to 2.5 Gbps (OC48)
- circa 2003: 10 Gbps (OC192)

Backbone speeds are behind limits of transmission tech.

<http://www.zakon.org/robert/internet/timeline/>

Backbone link speed growth

Roughly doubles every two years (45% per year)

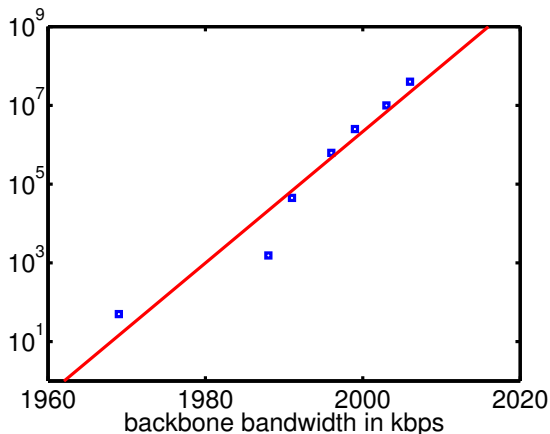

Backbone link bandwidth in kbps

Note that extra links are added every year

Early Internet Bandwidth Growth

Access link speeds grow as well

- Nielsen's Law of Internet Bandwidth

- ▶ a high-end user's connection speed grows by 50% per year
- ▶ <http://www.useit.com/alertbox/980405.html>

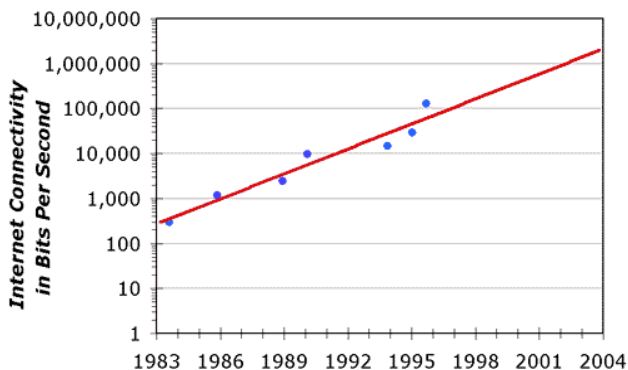

Internet Traffic Growth

Traffic roughly doubles every year [OdI03].

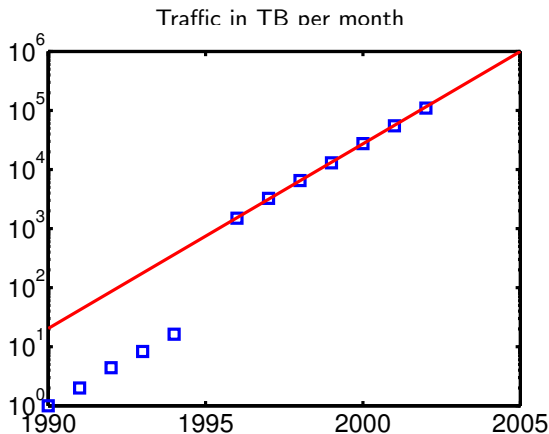

Combination of new users and higher bandwidth!

Australian Traffic Growth

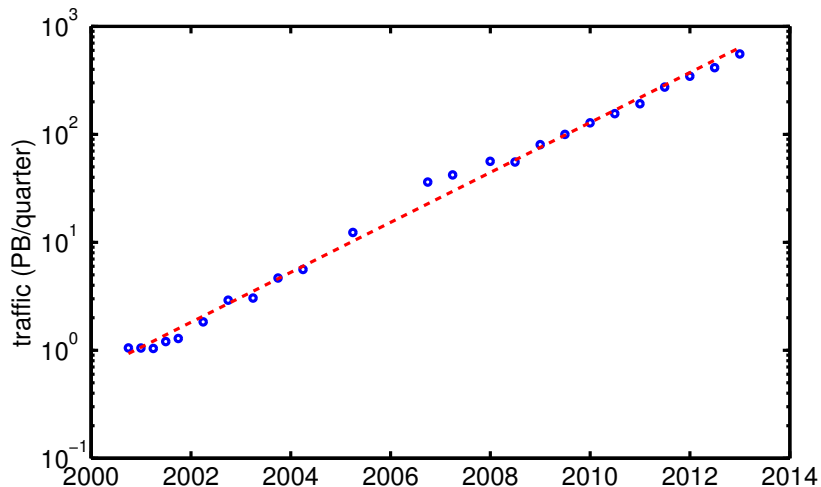

www.abs.gov.au

Part I

A Brief History of Communications Networks

You know what they say. Those of us who fail history, are doomed to repeat it in summer school.

Buffy (the Vampire Slayer), "After Life" (Season 6, Ep. 3), 2001

Dumb network design

One link between every pair who wish to speak

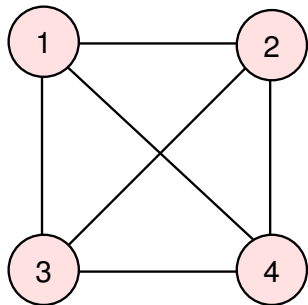

$N=4$
 $L=6$

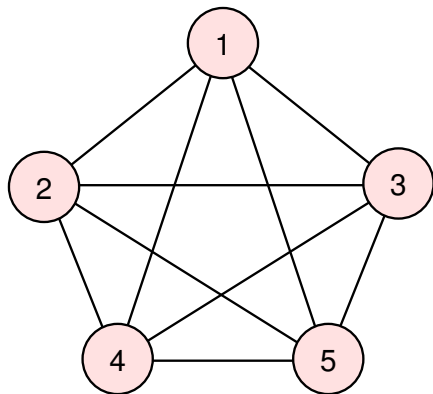

$N=5$
 $L=9$

N nodes, then we have $L=N(N-1)/2$ links

Dumb network design

Pratt, Kansas

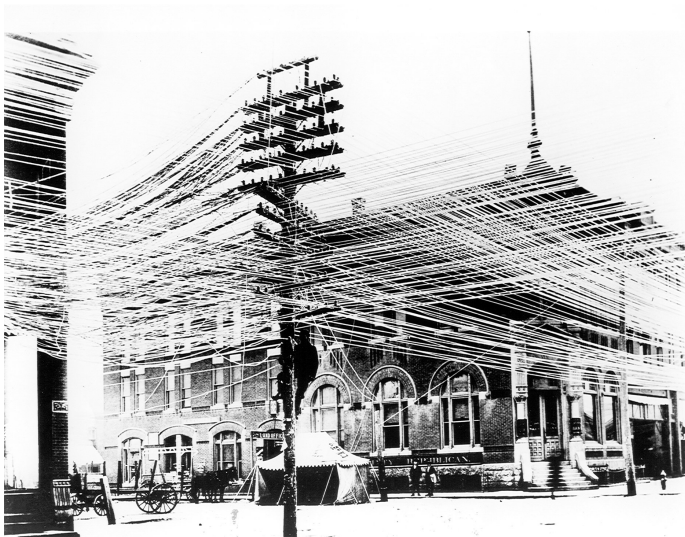

http://www.bellssystememorial.com/oldphotos_6.html

PUT BACK PARTS ON SWITCHING

Towards modern telephony

- switching
 - ▶ electronic switch (instead of electromechanical)
 - ▶ 4ESS (like a building)
<http://www.att.com/history/nethistory/switching.html>
- networks become hierachical
 - ▶ long distance versus local
- reliability and redundancy become important
 - ▶ alternate routing
- billing systems
 - ▶ harder than you think!

Some additional links

More detailed telephony timelines can be found at

<http://www.telephonetribute.com/timeline.html>

<http://www2.fht-esslingen.de/telehistory/>

<http://www.webbconsult.com/hist-time.html>

http://www.ieee.org/organizations/history_center/comsoc/timelines.html

<http://williamstallings.com/Extras/Telecom.html>

<http://aronsson.se/hist.html>

Histories of computing and computer networks

http://en.wikipedia.org/wiki/Computing_timeline

<http://www.isoc.org/internet/history/>

<http://www.isoc.org/internet/history/brief.shtml>

<http://www.dei.isep.ipp.pt/docs/arpa.html>

<http://www.zakon.org/robert/internet/timeline/>

http://en.wikipedia.org/wiki/History_of_the_Internet

<http://goldenink.com/computersandnetworks.shtml>

<http://www.davesite.com/webstation/net-history.shtml>

http://www.computerhistory.org/exhibits/internet_history/

<http://www.tranquileye.com/cyber/>

Section 2

Computer Networks

Computer pre-history

- The original “computers” were people
 - ▶ numerical algorithms performed with pencil and paper
 - ▶ later with mechanical adding machines
- Algorithms were often parallelized
 - ▶ multiple computers worked on same problem to speed up or check calculations
 - ▶ a “computer network” was result of passing bits of paper

20th century

Computer networks:

- First generation of electrical digital computers 1940s
- Second generation – late 1950s and early 1960s
 - ▶ transistor invented in 1947 (at AT&T)
 - ▶ direct networks: peripherals such as printers directly attached to computers
- Third generation, post-1964
 - ▶ integrated circuits
 - ▶ real computer networks start
- 1965, Moore's law discovered
 - ▶ computers get better and better ...

Networking drivers

- Moore's law drives PC business
- Gilder's law drives networks
 - ▶ something suss here – lets discuss later
- Metcalfe's law also drives the Internet
 - ▶ The value of a network is proportional to the square of the number of users.
 - ▶ hence the failure of many “video-phone” trials
 - ★ but success of most recent “camera phones”

The Internet

- Leonard Kleinrock at MIT published the first paper on **packet switching** theory in, July 1961 [L.K61].
- J.C.R. Licklider of MIT wrote memos “Galactic Network”, and later convinced DARPA to fund, 1962.
- Baran defence proposal for robust network was a packet switched network, 1962 [Bar64].
- Thomas Merrill, Larry Roberts, first network 1965
- Roberts’s plan for the “ARPANET”, published 1967
- IMP’s (built by BBN) connected 1968-69
- 1972: First public demo, e-mail invented
- Vinton Cerf and Robert Kahn, TCP/IP, 1973

<http://www.isoc.org/internet/history/brief.shtml>

The Early Internet

Kleinrock's insight [L.K61]

- computer traffic is bursty (it comes in spurts)
- more efficient to transmit packets of data on-demand than to reserve circuits between computers
 - ▶ setting up a circuit takes time (high latency)
 - ▶ keeping up a circuit set up is inefficient
 - ★ not used most of the time
 - ▶ all you want to do is send one little chunk of data
 - ★ example: typing – one character at a time
 - ★ even a whole email is quite small
 - ▶ alternative: send data as packets

The Early Internet

Paul Baran, 1960s, envisioned a comm.s network that would survive a major enemy attack. The sketch shows three network topologies described in [Bar64].

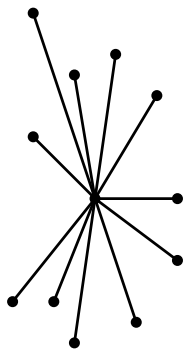

centralized

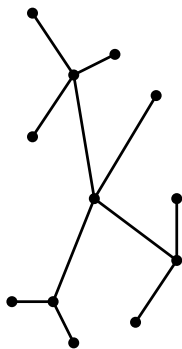

decentralized

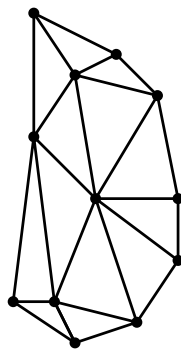

distributed

Original available at

<http://www.cybergeography.org/atlas/historical.html>

The Early Internet

A rough sketch map of the possible topology of ARPANET by Larry Roberts. Drawn in the late 1960s as part of the planning for the network [HL96, p.50].

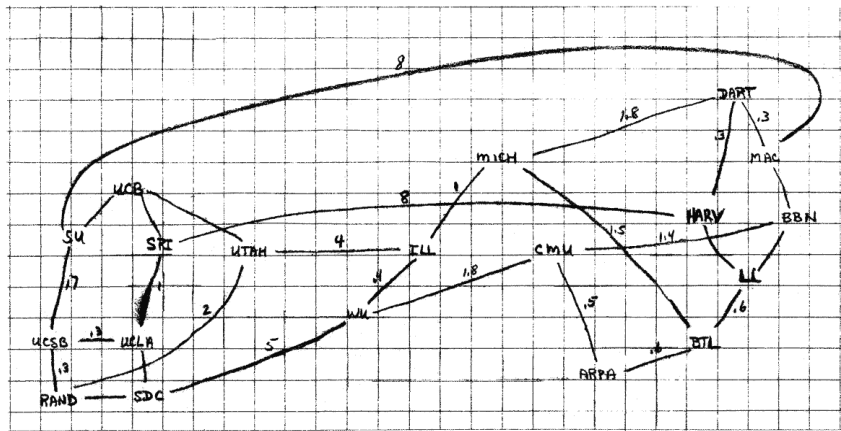

<http://www.cybergeography.org/atlas/historical.html>

The Early Internet

The first node on ARPANET at University California Los Angeles (UCLA) on the 2nd of September 1969 [CK90].

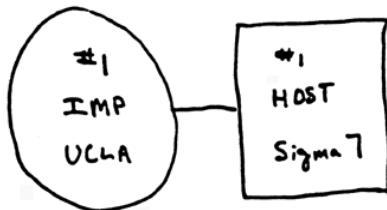

IMP = Interface Message Processor
what we would call a router

TIP = Terminal IMP

IMP to which terminals can directly connect

Host = computer (which provides services)

Available at

<http://www.cybergeography.org/atlas/historical.html>

The Early Internet

Dec 1969 "ARPA NETWORK". 4 nodes: Uni. of California Los Angeles (UCLA), Uni. of California Santa Barbara (UCSB), Uni. of Utah and the Stanford Research Institute (SRI) [CK90].

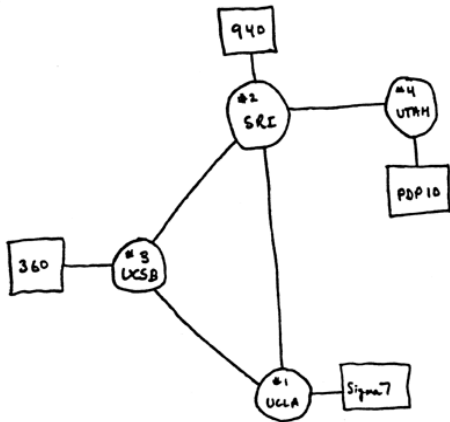

Available at

<http://www.cybergeography.org/atlas/historical.html>

The Early Internet

- a lot of effort went into design of the protocols, and architecture
- the actual network was designed more by constraints: geographic, cost, political, (i.e. who had funding to participate)
 - ▶ some formal optimization (Howard Frank in particular)
- you can design a network on the back of an envelope when it has 4 nodes.
 - ▶ not so easy with 100

The Early Internet

The map above shows the logical topology of ARPANET in April 1971. (computers connect direct to IMPs) [CK90].

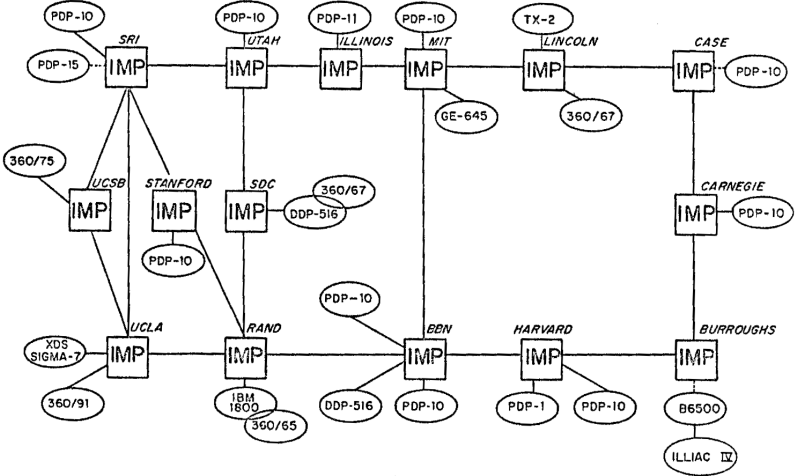

ARPA NET, APRIL 1971

The Early Internet

ARPANET grew rapidly as more sites are connected [CK90].

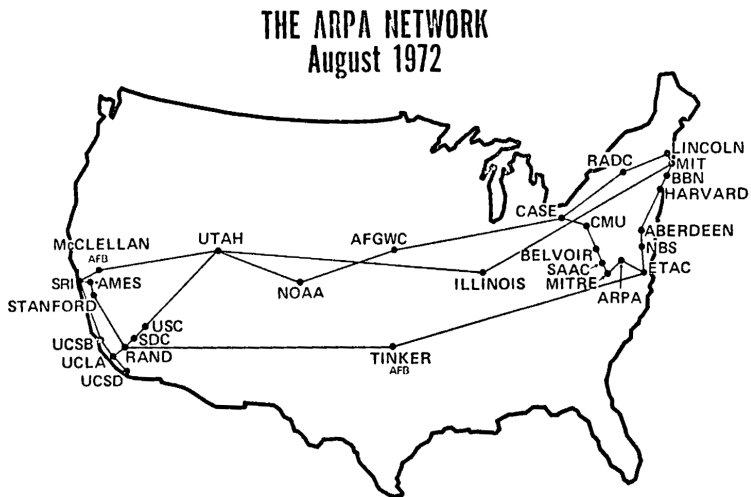

The Early Internet

ARPANET grew rapidly as more sites are connected [CK90].

ARPA NETWORK, GEOGRAPHIC MAP

JUNE 1975

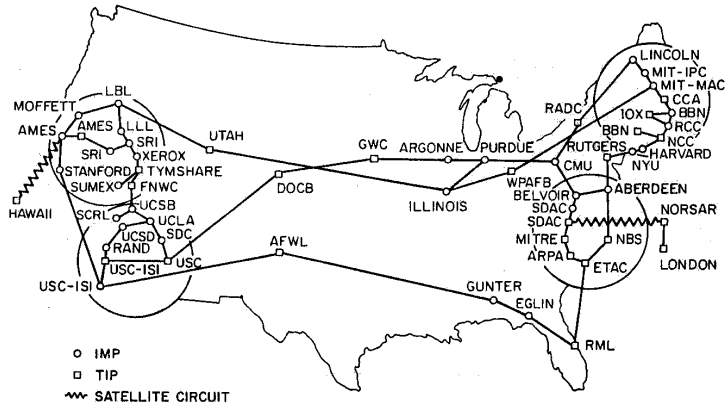

The Early Internet

ARPANET grew rapidly as more sites are connected [CK90].

ARPANET GEOGRAPHIC MAP, OCTOBER 1980

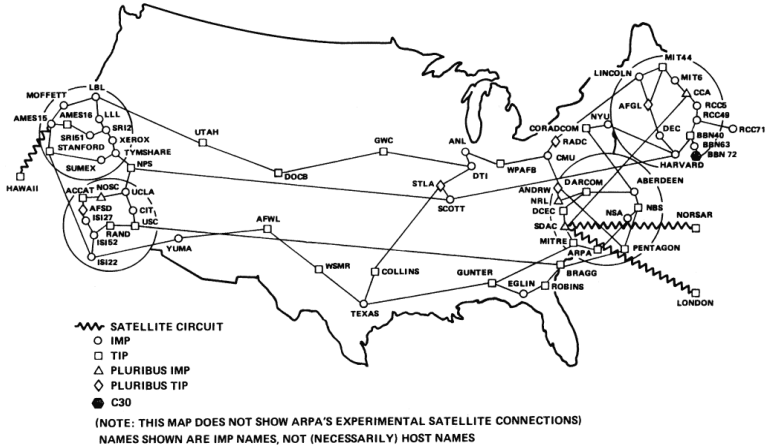

<http://www.cybergeography.org/atlas/historical.html>

The Internet: the 80's

- new developments
 - ▶ Personal Computers (PCs)
 - ⇒ lots more computers to network
 - ▶ Ethernet (1973, Robert Metcalfe) creates LANs
- the Internet
 - ▶ TCP/IP provides a way to hook up the LANs and PC over wide areas (standard in 1980)
 - ▶ scale gets bigger
 - ★ numbers increase
 - ★ becomes international
 - ▶ partitioning
 - ★ ARPANET splits into MILNET and ARPANET in early 80's, followed by further additions

The Internet: the 80's

ARPANET/MILNET [CK90].

ARPANET/MILNET GEOGRAPHIC MAP, APRIL 1984

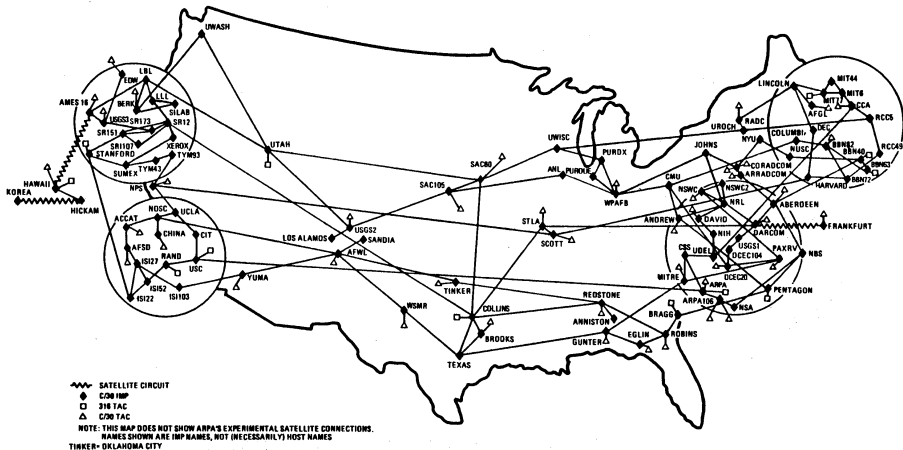

Early Internet Growth

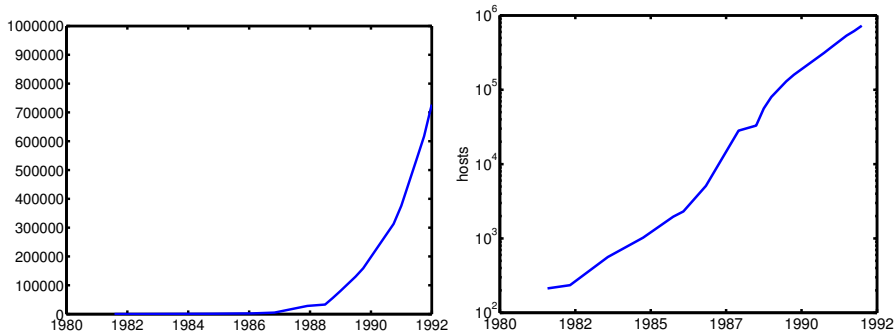

RFC 1296 <ftp://ftp.isi.edu/in-notes/rfc1296.txt>

Date (mm/yy)	hosts
08/1981	213
01/1992	727,000

The Early Internet

State of the core of the Internet in August 1987.

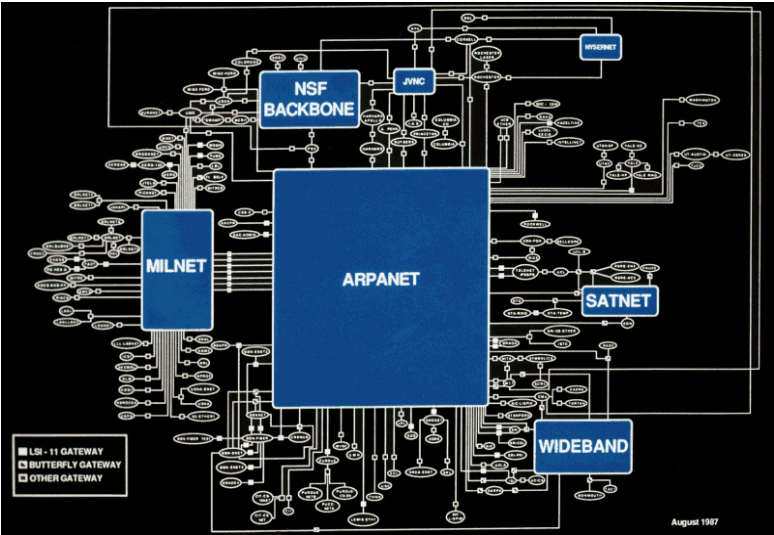

<http://www.cybergeography.org/atlas/historical.html>

Networks of networks

These maps show the structure of JANET, the UK's academic and research network, in 1992.

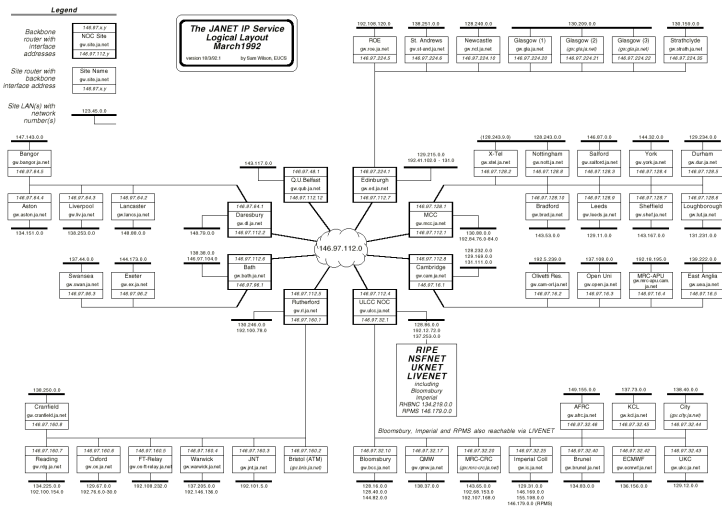

<http://www.cybergeography.org/atlas/historical.html>

The Internet: the 90's

- ARPANET decommissioned 1990
 - ▶ NSF Backbone connects many other networks
 - ★ Australia connected in 1990 [Abb99]

It was the first, and being first, was best,
but now we lay it down to rest.

Now pause with me a moment, shed some tears.

For auld langae syne, for love, for years and years
of faithful service, duty done, I weep.

Lay down thy packet, now, O friend, and sleep.

Vinton Cerf, 1989

- commercial Internet services evolve
 - ▶ 1995 NSFNET terminated (replaced by vBNS)
 - ▶ effectively fully privatised Internet
 - ▶ links through exchange points

The Internet: the 90's

Australia's network 1991

Australian Academic and Research Network

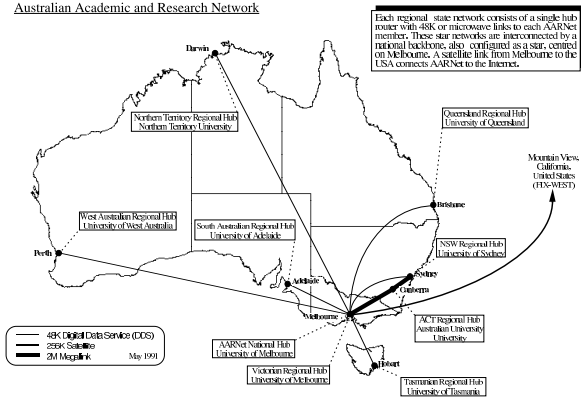

<http://www.ucs.ed.ac.uk/fmd/unix/edftp/pub/maps/>

New network

<http://www.aarnet.edu.au/engineering/aarnet3/>

The Internet: the 90's

<http://www.w3.org/History.html>

- 1990: World Wide Web
Tim Berners-Lee created HyperText Markup Language, or HTML. Along with URL (Uniform Resource Locators), and HTTP (HyperText Transfer Protocol), created the web. Based on earlier work at CERN (1980).
- 1993: Mosaic (Marc Andreessen, NCSA)
Mosaic became the first popular web browser. It was not only easy to use to access the World Wide Web, but it was also extremely easy to download and install!
- Killer app = the Internet takes off in a big way

Internet Traffic Growth

Traffic roughly doubles every year [OdI03].

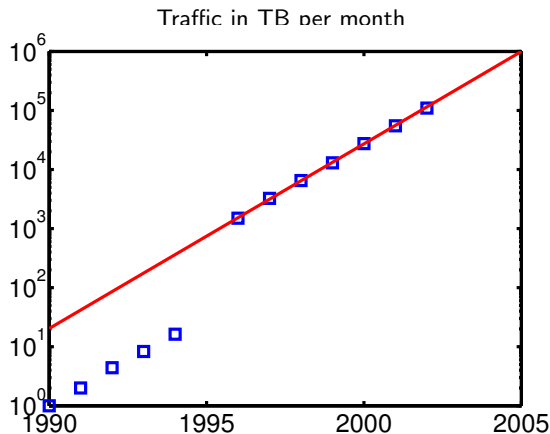

Combination of new users and higher bandwidth!

Australian Traffic Growth

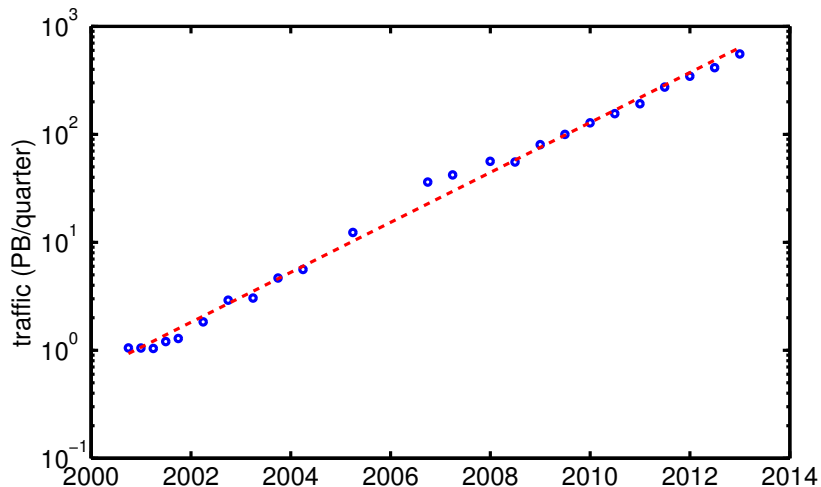

www.abs.gov.au

Other computer networks

The history of computer communications is not just about the Internet

- other technologies, e.g.
 - ▶ packet radio (Hawaii)
 - ▶ ATM/Framerelay
 - ▶ x.25
 - ▶ IBM's SNA
 - ▶ Appletalk
- other countries, e.g.
 - ▶ France
 - ▶ UK
- people: I haven't talked about them, but many individuals' contributions were critical [HL96, Abb99, Sal95].

BIT MORE ON HOW PACKET NETWORKS WORK

Further reading I

 Janet Abbate, *Inventing the internet*, MIT Press, 1999.

 Paul Baran, *On distributed communications: 1. introduction to distributed communications network*, RAND Memorandum, August 1964.

 V. Cerf and B. Kahn, *Selected ARPANET maps*, Computer Communications Review (CCR) **20** (1990), 81–110.

 Katie Hafner and Matthew Lyon, *Where wizards stay up late: The origins of the internet*, Touchstone, 1996.

 L.Kleinrock, *Information flow in large communication networks*, RLE Quarterly Progress Report, July 1961.

 Gordon E. Moore, *Cramming more components into integrated circuits*, Electronics **38** (1965), no. 8.

Further reading II



A. M. Odlyzko, *Internet traffic growth: Sources and implications*, Optical Transmission Systems and Equipment for WDM Networking II, Proc. SPIE, vol. 5247, 2003, pp. 1–15.



Peter H. Salus, *Casting the net: From ARPANET to Internet and beyond...*, Addison-Wesley, 1995.